

KIT PARTS DETAILS	
SENSOR DETAIL	SHEET 2 OF 5
SENSOR BRACKET DETAIL	SHEET 3 OF 5
REFLECTOR DETAIL	SHEET 4 OF 5
REFLECTOR BRACKET DETAIL	SHEET 5 OF 5

**EACH KIT CONTAINS: SENSOR, SENSOR BRACKET, REFLECTOR, AND REFLECTOR BRACKET**  
**PART NUMBER IN1-PE-KIT-RJ11-1 INCLUDES SENSOR WITH 1M CABLE**  
**PART NUMBER IN1-PE-KIT-RJ11-2 INCLUDES SENSOR WITH 2M CABLE**

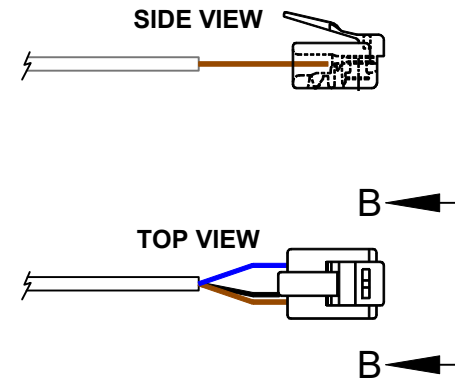

REV.	DATE	DESCRIPTION	✓	THE INFORMATION CONTAINED HEREIN IS CONFIDENTIAL, IS SUBMITTED IN CONFIDENCE, AND IS PROPRIETARY INFORMATION OF PULSEROLLER AND SHALL BE USED ONLY IN CONJUNCTION WITH AND PERFORMANCE OF THE CONTRACT OF WHICH THIS DRAWING FORMS A PART, AND SHALL NOT, WITHOUT PULSEROLLER PRIOR WRITTEN APPROVAL, BE REPRODUCED OR IN ANY OTHER WAY USED IN WHOLE OR IN PART BY OTHERS.	DATE: 20-APR-2020 DESIGNED BY: JPK CHECKED BY: SCALE: NONE SHEET: 1 OF 5	TITLE: PHOTOEYE KIT QS18 W/ REFLECTOR & BRKTS PART NUMBER IN1-PE-KIT-RJ11-X FOR: CONVEYSENSE PRODUCTS PULSEROLLER STANDARDS DWG. NO: IN1-PE-KIT-RJ11-X REV:
------	------	-------------	---	---	--	--

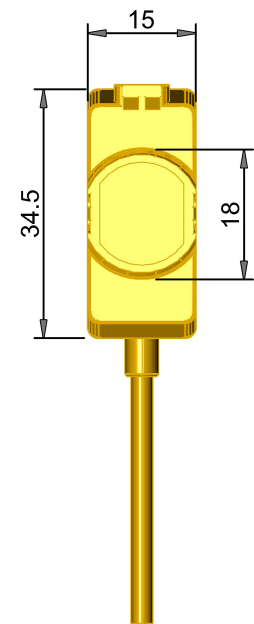
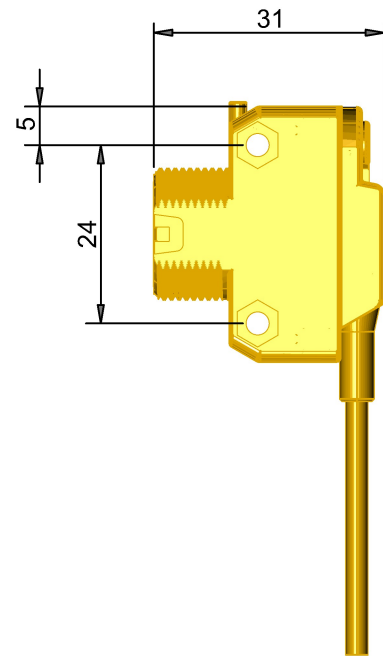

VIEW B-B

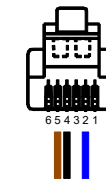

WIRING DIAGRAM		
P1	WIRE COLOR	
1	NOT USED	
2	BLUE	0VDC
3	NOT USED	
4	BLACK	Output
5	BROWN	24VDC
6	NOT USED	

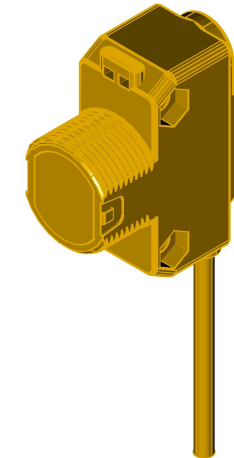

**ALL DIMENSIONS IN MM**  
**PART NUMBER IN1-PE-RJ11-1 WITH 1M CABLE**  
**PART NUMBER IN1-PE-RJ11-2 WITH 2M CABLE**



**PULSEROLLER**  
 WEB: WWW.PULSEROLLER.COM  
 SUPPORT: SUPPORT@PULSEROLLER.COM  
 SALES: SALES@PULSEROLLER.COM

REV.	DATE	DESCRIPTION	✓	THE INFORMATION CONTAINED HEREIN IS CONFIDENTIAL, IS SUBMITTED IN CONFIDENCE, AND IS PROPRIETARY INFORMATION OF PULSEROLLER AND SHALL BE USED ONLY IN CONJUNCTION WITH AND PERFORMANCE OF THE CONTRACT OF WHICH THIS DRAWING FORMS A PART, AND SHALL NOT, WITHOUT PULSEROLLER PRIOR WRITTEN APPROVAL, BE REPRODUCED OR IN ANY OTHER WAY USED IN WHOLE OR IN PART BY OTHERS.	DATE: 20-APR-2020 DESIGNED BY: JPK CHECKED BY: SCALE: NONE SHEET: 2 OF 5	TITLE: PHOTOEYE KIT QS18 W/ REFLECTOR & BRKTS PART NUMBER IN1-PE-KIT-RJ11-X FOR: CONVEYSENSE PRODUCTS PULSEROLLER STANDARDS DWG. NO: IN1-PE-KIT-RJ11-X REV:
------	------	-------------	---	---	--	--

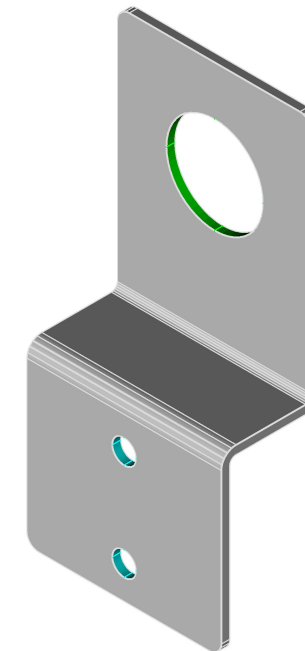
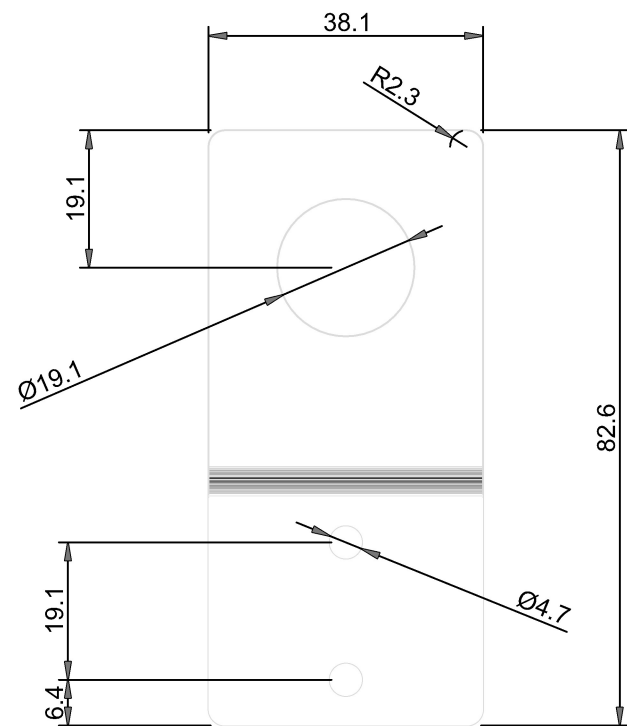
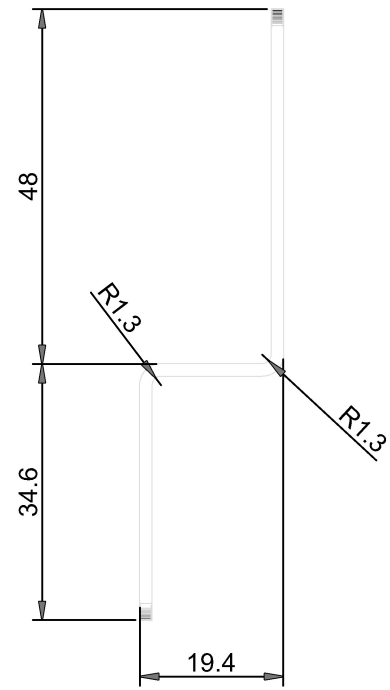

**ALL DIMENSIONS IN MM  
PART NUMBER 123459**



REV.	DATE	DESCRIPTION	✓

THE INFORMATION CONTAINED HEREIN IS CONFIDENTIAL, IS SUBMITTED IN CONFIDENCE, AND IS PROPRIETARY INFORMATION OF PULSEROLLER AND SHALL BE USED ONLY IN CONJUNCTION WITH AND PERFORMANCE OF THE CONTRACT OF WHICH THIS DRAWING FORMS A PART, AND SHALL NOT, WITHOUT PULSEROLLER PRIOR WRITTEN APPROVAL, BE REPRODUCED OR IN ANY OTHER WAY USED IN WHOLE OR IN PART BY OTHERS.

DATE: 20-APR-2020  
 DESIGNED BY: JPK  
 CHECKED BY:  
 SCALE: NONE  
 SHEET: 3 OF 5

TITLE: PHOTOEYE KIT QS18 W/ REFLECTOR & BRKTS  
 PART NUMBER IN1-PE-KIT-RJ11-X  
 FOR: CONVEYSENSE PRODUCTS  
 PULSEROLLER STANDARDS  
 DWG. NO: IN1-PE-KIT-RJ11-X  
 REV:

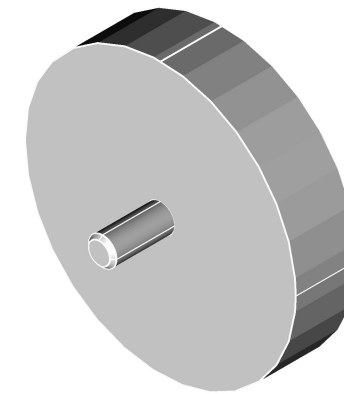
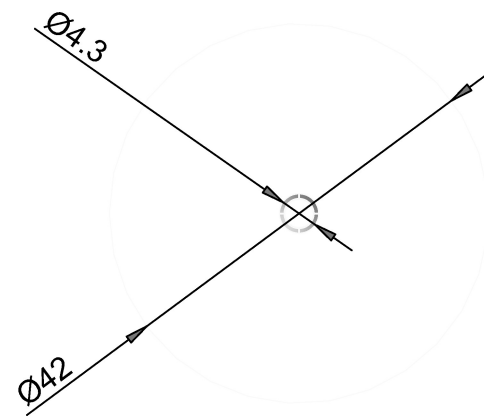
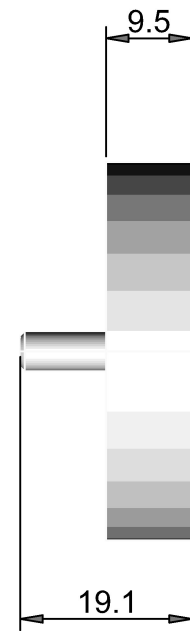

**ALL DIMENSIONS IN MM  
PART NUMBER IN-REF-42D**



REV.	DATE	DESCRIPTION	✓	THE INFORMATION CONTAINED HEREIN IS CONFIDENTIAL, IS SUBMITTED IN CONFIDENCE, AND IS PROPRIETARY INFORMATION OF PULSEROLLER AND SHALL BE USED ONLY IN CONJUNCTION WITH AND PERFORMANCE OF THE CONTRACT OF WHICH THIS DRAWING FORMS A PART, AND SHALL NOT, WITHOUT PULSEROLLER PRIOR WRITTEN APPROVAL, BE REPRODUCED OR IN ANY OTHER WAY USED IN WHOLE OR IN PART BY OTHERS.	DATE: 20-APR-2020	TITLE: PHOTOEYE KIT QS18 W/ REFLECTOR & BRKTS PART NUMBER IN1-PE-KIT-RJ11-X
					DESIGNED BY: JPK	FOR: CONVEYSENSE PRODUCTS PULSEROLLER STANDARDS
					CHECKED BY:	
					SCALE: NONE	
					SHEET: 4 OF 5	DWG. NO: IN1-PE-KIT-RJ11-X
						REV:

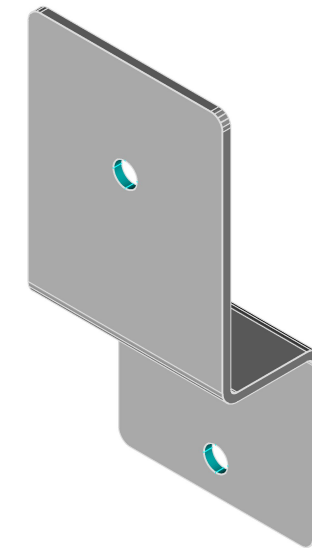
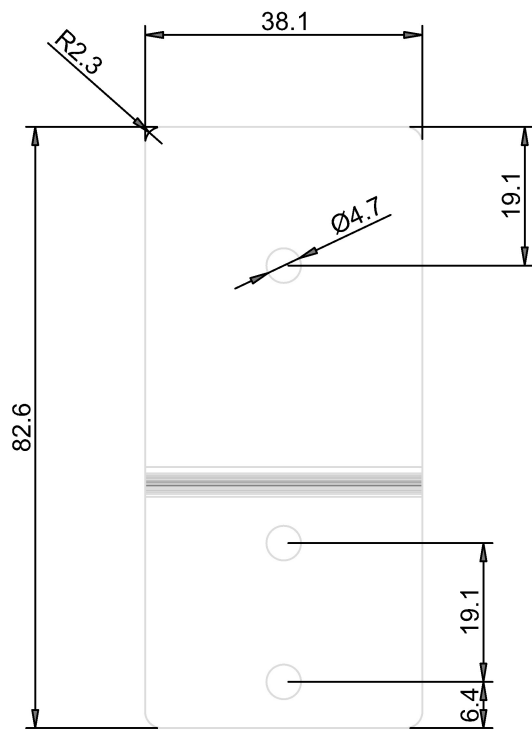
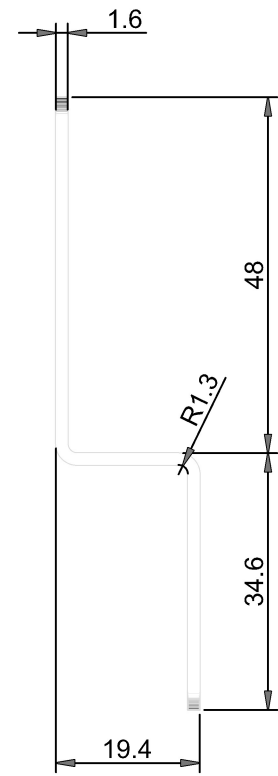

**ALL DIMENSIONS IN MM  
PART NUMBER 123460**



REV.	DATE	DESCRIPTION	✓

THE INFORMATION CONTAINED HEREIN IS CONFIDENTIAL, IS SUBMITTED IN CONFIDENCE, AND IS PROPRIETARY INFORMATION OF PULSEROLLER AND SHALL BE USED ONLY IN CONJUNCTION WITH AND PERFORMANCE OF THE CONTRACT OF WHICH THIS DRAWING FORMS A PART, AND SHALL NOT, WITHOUT PULSEROLLER PRIOR WRITTEN APPROVAL, BE REPRODUCED OR IN ANY OTHER WAY USED IN WHOLE OR IN PART BY OTHERS.

DATE:	20-APR-2020
DESIGNED BY:	JPK
CHECKED BY:	
SCALE:	NONE
SHEET:	5 OF 5

TITLE:	PHOTOEYE KIT QS18 W/ REFLECTOR & BRKTS PART NUMBER IN1-PE-KIT-RJ11-X
FOR:	CONVEYSENSE PRODUCTS PULSEROLLER STANDARDS
DWG. NO:	IN1-PE-KIT-RJ11-X
REV:	